

# ECONOMY

## SPRING HINGES

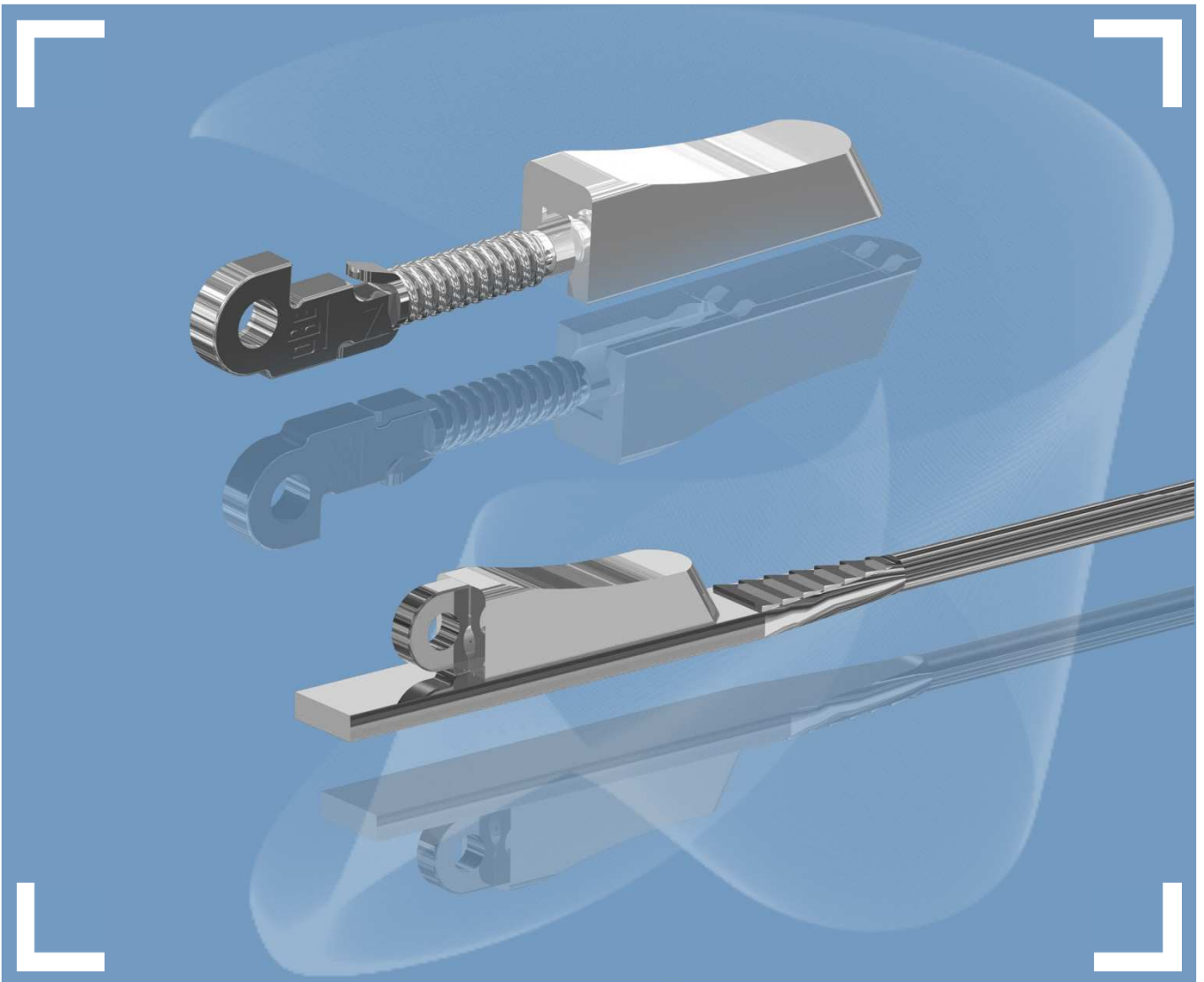

# LITE-Line

Easy processing with closed bottom

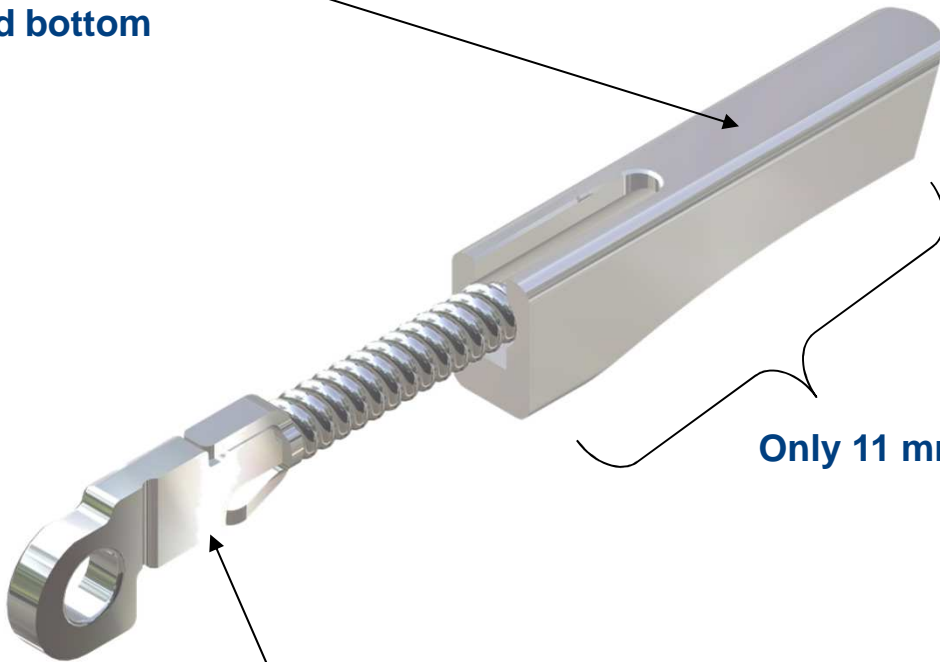





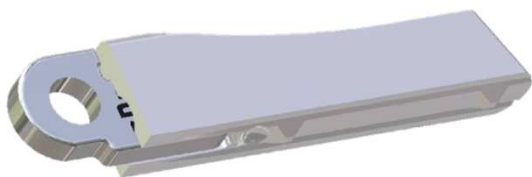





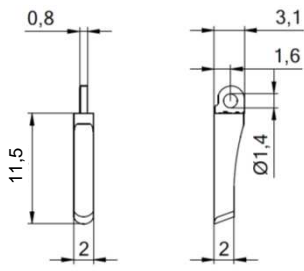
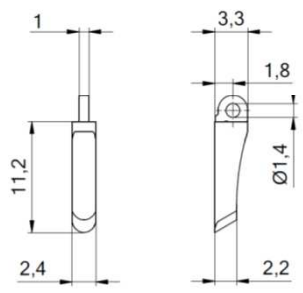
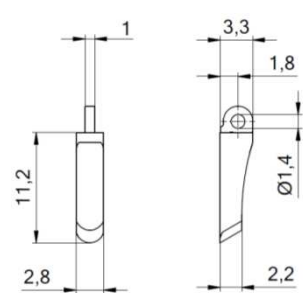
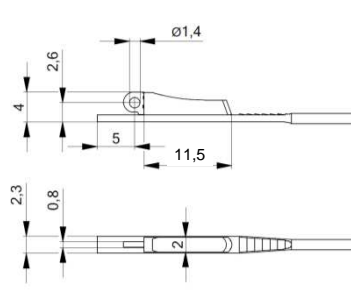
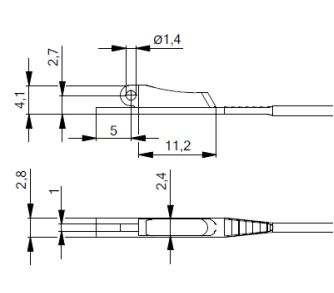
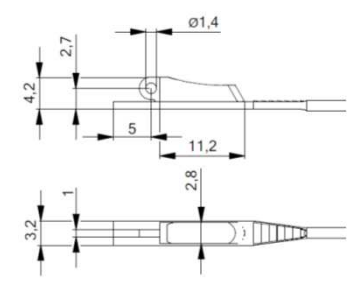
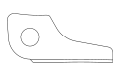
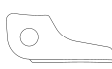













Only 11 mm case length

Proven click-in mechanism from stainless steel



Case soldered on wire for plastic application

# LITE-Line

	2.0 mm	2.4 mm	2.8 mm
			
			
<b>Art No</b>	60-08080 / 73-08080	60-08084 / 73-08084	60-08088 / 73-08088
<b>Technical data</b>			
Material case	nickel silver		
Delivery status for soldering on wire	case & mechanism separate pre-assembled		
Screw system	conical head M1.4, minus or plus-minus		
<b>Matching parts</b>			
Front hinges for soldering	 52-05075	 52-05097	 52-05194
Front hinges for plastic frames 90°	 33-05105	 33-05104	 33-05106
Front hinges for plastic frames 180°	 33-05010	 33-05012	 33-05063
Step hinges for soldering	 52-05112	 52-05111	 52-05153
Screws	  99-01803   99-02530	  99-01811   99-02525   99-04811	  99-01813   99-02501



**OBE Ohnmacht & Baumgärtner GmbH & Co. KG · Turnstr. 22 · 75228 Ispringen · Germany**  
**Tel. +49 7231 802-0 · Fax +49 7231 802-156 · [www.obe.de](http://www.obe.de) · [info@obe.de](mailto:info@obe.de)**