



# Air Active®

High-comfort thanks to air cushion



F&W Frey&Winkler GmbH

Benzstraße 13  
PO Box 2109  
75203 Königsbach-Stein

Phone: +49 7232 / 30 54-0  
Fax: +49 7232 / 27 90  
E-Mail: [mail@freywinkler.de](mailto:mail@freywinkler.de)  
Web: [www.freywinkler.de](http://www.freywinkler.de)

Focusing on high comfort and customer need, F&W invented a new type of nose pad with even more wearing comfort than regular silicone pads. In addition to the benefits offered by pads made of silicone, an air cushion system makes this pad even more comfortable to wear. Inside the anti-allergic silicone pad, there is a hollow chamber and an opening at one end. This creates an air cushion - the opening works like a valve enabling the pad to adjust itself automatically. What an ACTIVE pad!

Air Active® pads are available in several sizes; in click and screw-type.

**100% Made in Germany in our own facilities  
and with tested materials only**



## Click Type

Article 60648  
Size 13 mm

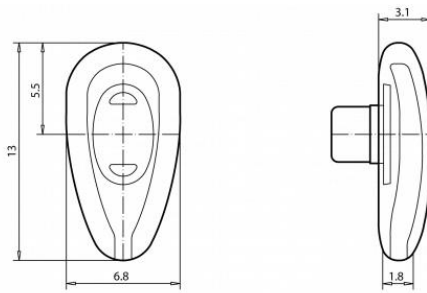

with polycarbonate insert

Article 60961  
Size 14.5 mm

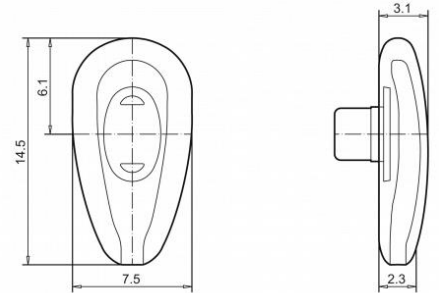

with polycarbonate insert

Article 60962  
Size 17 mm

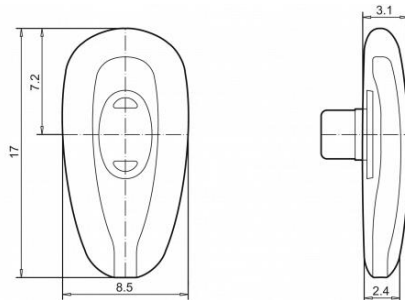

with polycarbonate insert



## Screw Type

Article 60629  
Size 11 mm

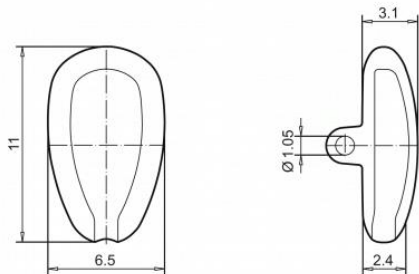

Article 60636  
Size 14.5 mm

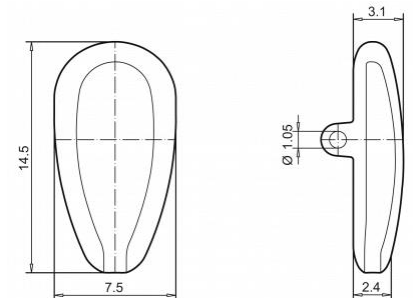

Article 60889  
Size 14,5 mm

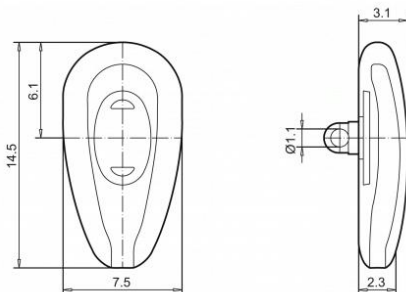

with polycarbonate insert

Article 60721  
Size 17 mm

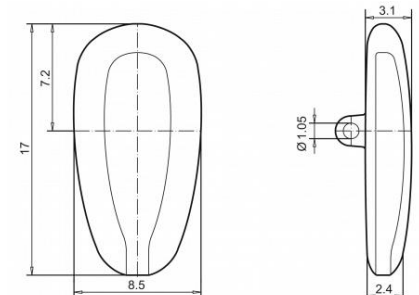

**Body:** Thin elastic body made of anti-allergic silicone, featuring air chamber and corresponding valve  
**Insert:** Either with polycarbonate insert and silicone body or no insert, just pure silicone

For details please visit our online catalogue at: [www.freywinkler.de/online\\_catalogue](http://www.freywinkler.de/online_catalogue)

Check out our other series of air cushion pads: **Air Tec®!**

Patent Pending